

# PRODUCT MERCHANDISERS

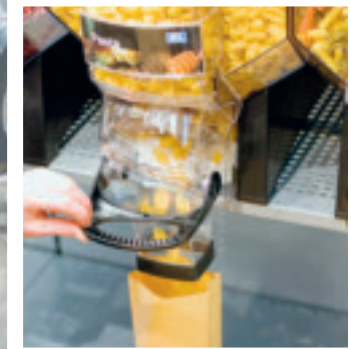

## MANY PRODUCTS ARE BULK BEST SELLERS!

Organic foods and fair trade products are one of the fastest growing segments within food retail. Bulk Bins is an excellent way to differentiate toward competition, create shopping destinations within the store and improve profits!



## Create new business opportunities



The three e's in 3eBins summarises the three main features of our Bulk Bins:

**Ecologic.** Bulk foods provides a more “eco-friendly” way of shopping. Less resources are used in both transport and packaging when products are sold in bulk as opposed to pre-packed.

**Economic.** Our Bulk Bins both provide a cost effective solution for our customers – and an opportunity for selling at increased gross margins.

**Ergonomic.** With the help of our industrial designers, we have created a range which is both easy to handle for the consumer, and easy to use for the store.





## A NEW BUSINESS OPPORTUNITY FOR RETAILERS

Customers prefer to be able to choose themselves how much they buy and what they buy. Bulk presentations allows consumers to mix and test new products without having to buy a whole package.

Bulk is an easy way to adapt the offer to the microeconomic environment (premium, ethnic or value offer). Bulk allows better and swifter adaption to local demand than pre-packed goods. Bulk bins are a great way to present and stimulate the growing interest in organic foods and fair trade products.

Seeing the product and being able to measure yourself appeals to the customer and brings store loyalty.



## SCOOP BINS

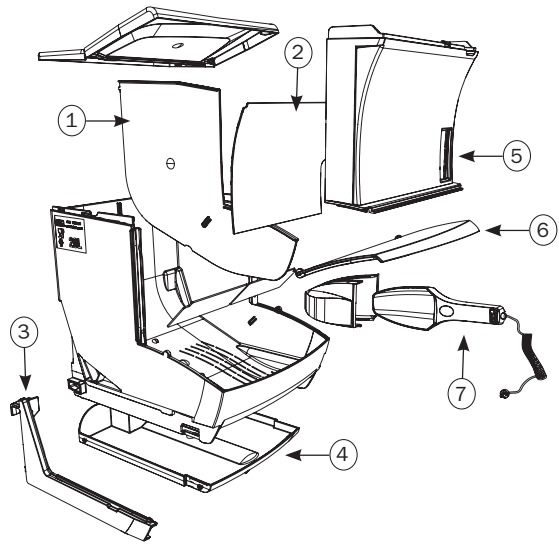

- 1: Divider
- 2: Image holder
- 3: Brackets
- 4: Catch tray

- 5: Scoop holder
- 6: Consumer Lid
- 7: Scoop

### TECHNICAL FEATURES

Virtually unbreakable material approved for food contact. European standard with 20 or 10+10 liters. Options: with or without middle divider, label holder on the lid, scoop or tong, flow control/shutter, product image holder, catch tray.

### FIFO PRINCIPLE

«First in, first out». Our scoop bins offer automatic stock rotation to maintain product freshness and quality with an unique angled container floor.

### IN-STORE SEGMENTATION

Our scoop bins models are equipped with a perpendicular holder to support any kind of shelftalker or aisle sign. The bin allows both product image on the vertical front and product/price info on the consumer lid.

### CLEANING AND RE-STOCKING

Our scoop bins are dust proof to protect the merchandise from external contact. Each bin has an integrated scoop or tong for improved hygiene. Hinged lid cover facilitates remerchandising. Bins need to be cleaned regularly to always give a fresh impression.

### INSTALLATION

#### - on shelves

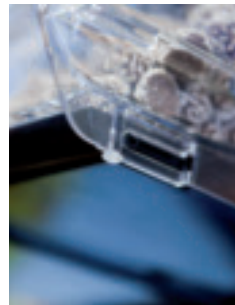

Anti-skidpads prevents bins from moving accidentally

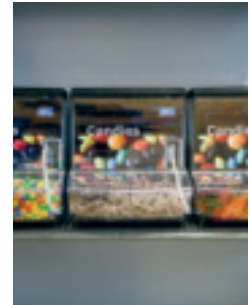

Once the anti-skid pads are fitted, simply position the bins on the shelf.

#### - On cross bars



Install the cross bar and place brackets in the desired position

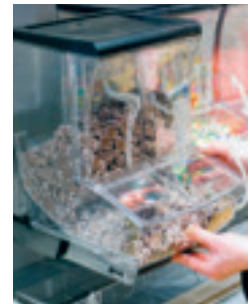

Connect the bin to the bracket



## GRAVITY BINS



### INSTALLATION - on shelves



Fasten the profile onto the shelf and fix the bin foot into the profile.



Angle bin slightly when inserting it into the profile.

### - On cross bars



Install cross bar and place the metal holder(s) in the desired position(s).



Connect the bin to the metal holder.

### TECHNICAL FEATURES

Virtually unbreakable material approved for food contact. European standard from 7,5 up to 50 liters. Easy flow adjustment. Anti-bag slip. Optional agitator.

### FIFO PRINCIPLE

«First in, first out». Our gravity bins offer automatic stock rotation to maintain product freshness and quality.

### IN-STORE SEGMENTATION

Our gravity bins models are equipped with a perpendicular holder to support any kind of shelftalker or aisle sign.

### CLEANING AND RE-STOCKING

Our gravity bins are sealed to protect the merchandise from external contact. Bins need to be cleaned regularly to always give a fresh impression. The frequency depends on the type of products.

### FLOW CONTROL

Product flow is easily adjusted from the side of the bin.



# PRODUCT MERCHANDISERS

## ➤ SCOOP BINS – STANDARD VERSIONS



SB300-20L TSL

**20 litre bin**

300 mm wide. 345 mm high.  
375 mm deep. Options included: Catch Tray,  
Scoop, Label holder on consumer lid



SB300-20L SL

**20 litre bin**

300 mm wide. 345 mm high.  
375 mm deep.  
Options included: Scoop. Label holder on consumer lid.



SB300-20L TSLD

**10+10 litre bin**

300 mm wide. 345 mm high.  
375 mm deep.  
Options included: Catch tray. Scoop. Label holder on consumer lid.  
Middle divider

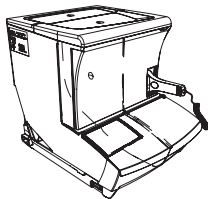

SB300-20L SLD

**10+10 litre bin**

300 mm wide. 345 mm high.  
375 mm deep.  
Options included: Scoop. Label holder on consumer lid.  
Middle divider

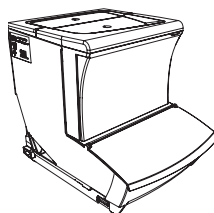

SB300-20L

**20 litre bin**

300 mm wide. 345 mm high.  
375 mm deep.  
Options included: None. Base version without scoop.



## ➤ SCOOP BIN ACCESSORIES

SB SCOOP

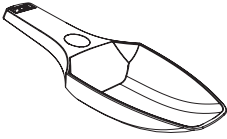

### **Scoop**

Transparent scoop made in resistant material.



SB TONG

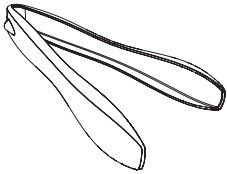

### **Tong**

Black tong made in resistant material.



SB300 SHUTTER WIDE

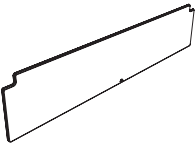

### **Wide shutter for free-flowing products**

Used to avoid accidental overflowing.



SB300 SHUTTER NARROW

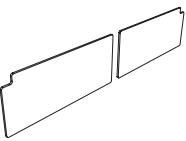

### **Narrow shutter for free-flowing products**

The shutter is used to avoid accidental overflowing. For version with middle divider, two shutters can be used – one for each compartment.



BUMPON

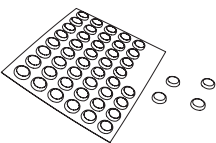

### **Plastic anti-skid pad**

Used for placing scoop bins directly on existing shelving. Use 4 bumpons (1 in each corner) to avoid that bins move accidentally.



# PRODUCT MERCHANDISERS

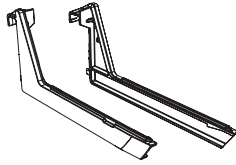

SB BRACKET

## SB bracket

Brackets (supplied in pairs left+right) fitting both SB200 & SB300. With connection lug at the back.

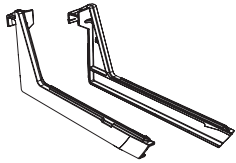

SB BRACKET 2

## SB bracket

Brackets (supplied in pairs left+right) fitting both SB200 & SB300. Without connection lug at the back.



## ➤ GRAVITY BINS – STANDARD VERSIONS WITHOUT MOVING FLOOR/AGITATOR

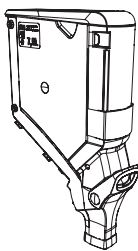

GB100-7,5 LTR

## 7.5 litre bin

100 mm wide.  
535 mm high.  
350 mm deep

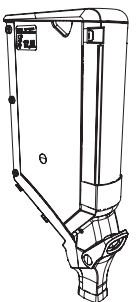

GB100-12,5 LTR

## 12.5 litre bin

100 mm wide.  
710 mm high.  
350 mm deep.



# BULK BINS

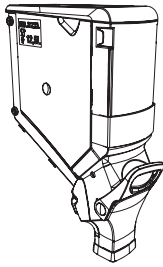

GB150-12,5 LTR

**12.5 litre bin**

150 mm wide.  
535 mm high.  
350 mm deep.

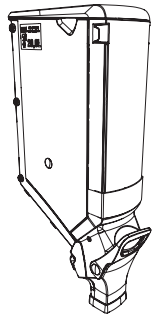

GB150-20 LTR

**20 litre bin**

150 mm wide.  
710 mm high.  
350 mm deep.

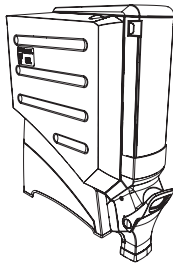

GB300-50 L F

**50 litre bin**

300 mm wide.  
710 mm high.  
480 mm deep  
Always supplied with foot.

## ➤ GRAVITY BINS – STANDARD VERSIONS WITH MOVING FLOOR/AGITATOR

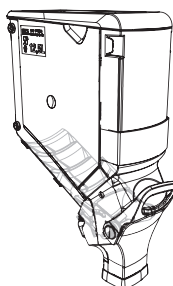

GB150A-12,5 LTR

**Agitator bin, 12,5 ltr**

Bin with a moving floor. Use for sticky or slow flowing products that needs stirring to feed properly. 150 mm wide. 535 mm high. 350 mm deep.





# PRODUCT MERCHANDISERS

## GRAVITY BIN ACCESSORIES

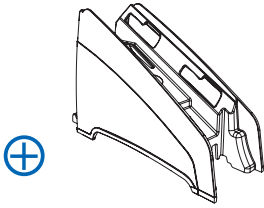

FOOT 100

**Foot**  
Base/Foot for GB100 models.

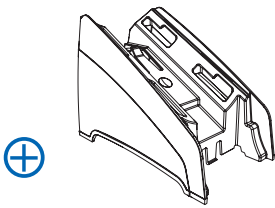

FOOT 150

**Foot**  
Base/Foot for GB150 models.

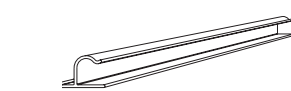

BBR taTTF19

**Back rail**  
Back rail to fix Bulk bin with base/foot.

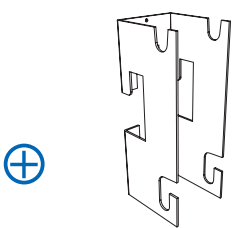

XH-100

**X-bar**  
X-bar Holder for GB100 models.

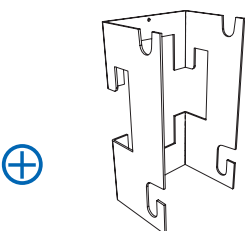

XH-150

**X-bar**  
X-bar Holder for GB150 models.



# BULK BINS

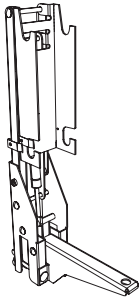

SD100

**Swing-down arm**  
Swing down arm for GB100

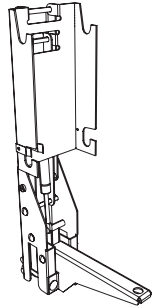

SD150

**Swing-down arm**  
Swing down arm for GB150

## SIGNAGE

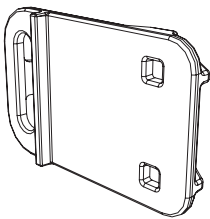

BINFLAG TF

**Sign holder**  
Clips onto either side of the bin in any vertical position along the two grooves on the side of the bin front. Compatible with both Scoop & Gravity Bins.



# PRODUCT MERCHANDISERS



The separate catch tray allows easy disposal of unwanted product particles.

The low and curved front facilitates product take out.

No old product left in the corners!

The integrated scoop with scoop holder and attachment is highly hygienic!

One scoop = one bin = one product.

Item	SB-200-12,5L*	SB-300-20L
Capacity (L)	12,5	20
Width (mm)	200	300
Height (mm)	345	345
Depth (mm)	375	375

\*: Available Q4 2010



# BULK BINS



Item	GB-100-7,5L	GB-100-12,5 L
Capacity (L)	7,5	12,5
Width (mm)	100	100
Height (mm)	535	710
Depth (mm)	350	350

Item	GB-150-12,5L GB150A-12,5 L	GB-150-20 L
Capacity (L)	12,5	20
Width (mm)	150	150
Height (mm)	535	710
Depth (mm)	350	350

Item	GB-300-50L
Capacity (L)	50
Width (mm)	300
Height (mm)	710
Depth (mm)	480

